

N-CHANNEL SiC POWER MOSFET

Features

- $R_{DS(on)}=40m\Omega$ (Typ.) @ $V_{GS}=20V, I_D=60A$
- High Blocking Voltage with Low On-Resistance
- High Speed Switching with Low Capacitance
- Easy to Parallel and Simple to Drive

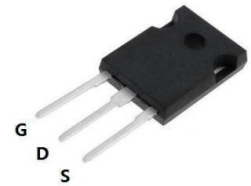

Applications

- Solar inverters
- DC/DC converters
- Motor drives
- Switch Mode Power Supplies

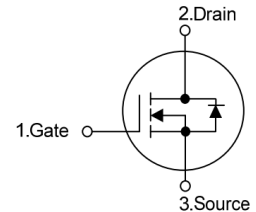

Key Performance and Package Parameters

Order codes	V_{DS}	I_D	$R_{DS(ON)}$, Typ	T_{vjmax}	Marking	Package
XD040B120BV1S3	1200V	60A	40m Ω	150 $^{\circ}C$	D40B120BV1	TO247-3

Absolute Maximum Ratings ($T_c= 25^{\circ}C$ unless otherwise specified.)

Symbol	Parameter	Value	Units
V_{DSS}	Drain-Source Voltage	1200	V
V_{GSmax}	Gate-Source Voltage	-10/+25	V
V_{GSop}	Gate-Source Voltage	-5/+20	V
I_D	Continuous Drain Current ($T_c=25^{\circ}C$)	60	A
I_{DM}	Pulsed Drain Current	160	A
P_D	Maximum Power Dissipation ($T_c=25^{\circ}C$)	330	W
T_J	Operating Junction Temperature Range	-55 to 150	$^{\circ}C$
T_{STG}	Storage Temperature Range	-55 to 150	$^{\circ}C$

Thermal Data

Symbol	Parameter	Conditions	Max.	Units
$R_{\theta JC}$	Thermal Resistance, Junction-to-Case (Steady State)	TO247	0.34	$^{\circ}C/W$

Electrical Characteristics ($T_c=25^{\circ}\text{C}$ unless otherwise specified.)

Symbol	Parameter	Conditions	Min.	Typ.	Max.	Unit
BV_{DSS}	Drain-Source Breakdown Voltage	$V_{GS}=0V, I_{DS}=100\mu A$	1200	---	---	V
I_{DSS}	Zero Gate Voltage Drain Current	$V_{DS}=1200V, V_{GS}=0V$	---	---	100	μA
I_{GSS}	Gate Leakage Current, Forward	$V_{GS}=25V, V_{DS}=0V$	---	---	250	nA
$V_{GS(th)}$	Gate Threshold Voltage	$V_{DS}=V_{GS}, I_{DS}=10mA$	1.9	2.5	4.0	V
$R_{DS(ON)}$	Drain-Source On-state Resistance	$V_{GS}=20V, I_{DS}=40A$	--	40	55	$m\Omega$
Q_g	Total Gate Charge	$V_{DS}=800V$	---	142	---	nC
Q_{gs}	Gate-Source Charge	$V_{GS}=-5V/20V$	---	37	---	nC
Q_{gd}	Gate-Drain Charge	$I_{DS}=40A$	---	18	---	nC
$t_{d(on)}$	Turn-on Delay Time	$V_{DD}=800V,$	---	12	---	ns
t_r	Rise Time	$V_{GS}=-5V/20V$	--	10	--	ns
$t_{d(off)}$	Turn-off Delay Time	$I_{DS}=40A, R_G=2.5\Omega$		25	---	ns
t_f	Fall Time		---	6.2	---	ns
C_{iss}	Input Capacitance	$V_{DS}=1000V$	---	2946	---	pF
C_{oss}	Output Capacitance	$V_{GS}=0V$	---	167	---	pF
C_{rss}	Reverse Transfer Capacitance	$f=1MHz$	---	6.6	---	pF

Reverse Diode Characteristics

Symbol	Parameter	Conditions	Min.	Typ.	Max.	Units
V_{SD}	Diode Forward Voltage	$I_{SD}=20A, V_{GS}=-5V$	---	4.5	---	V
t_{rr}	Diode Reverse Recovery Time	$V_R=800V,$ $I_{SD}=40A,$ $di_f/dt=1000A/s$	---	41	---	ns
Q_{rr}	Diode Reverse Recovery Charge		---	142	---	nC
I_{rrm}	Peak Reverse Recovery Current		---	6	---	A

Typical Characteristics

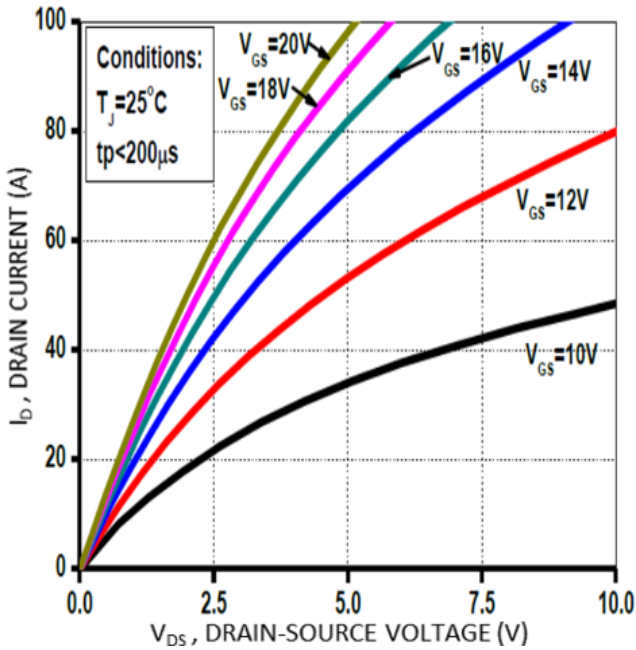

Fig.1 Output Characteristics

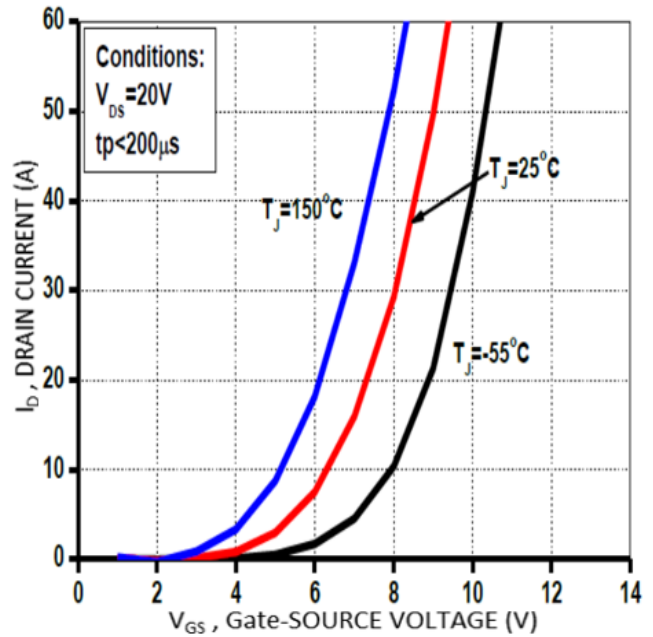

Fig.2 Output Characteristics

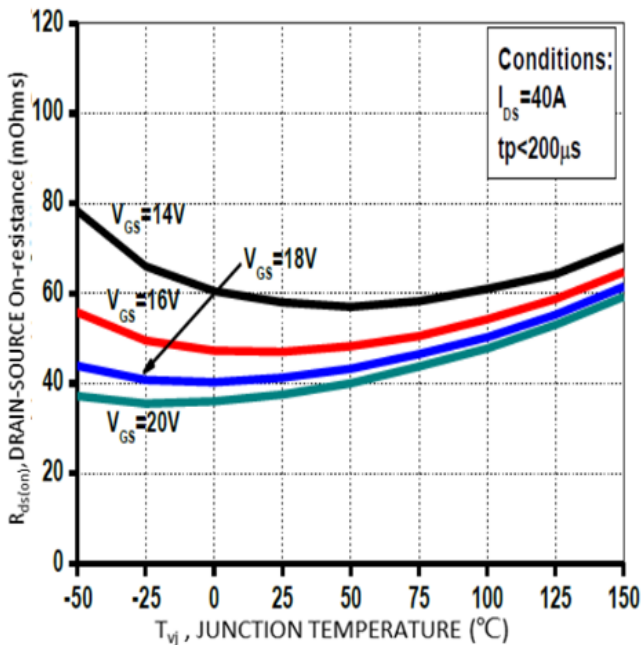

Fig.3 Drain-Source On Resistance

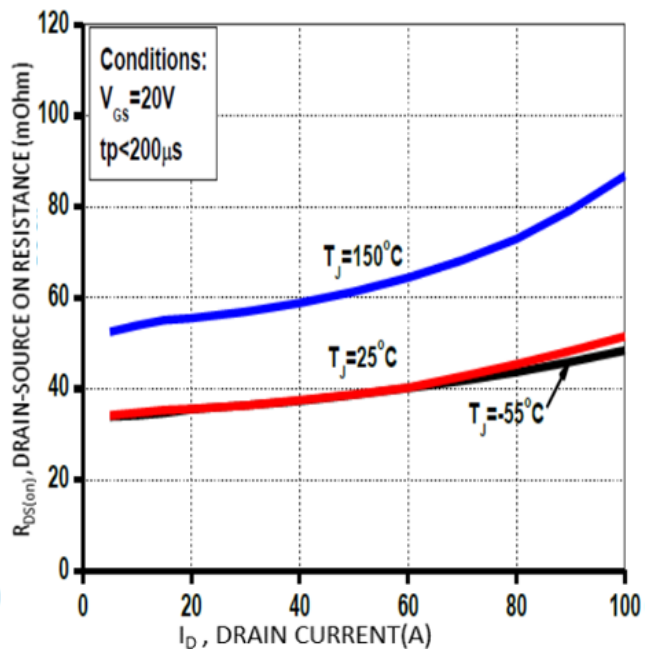

Fig.4 Drain-Source On Resistance

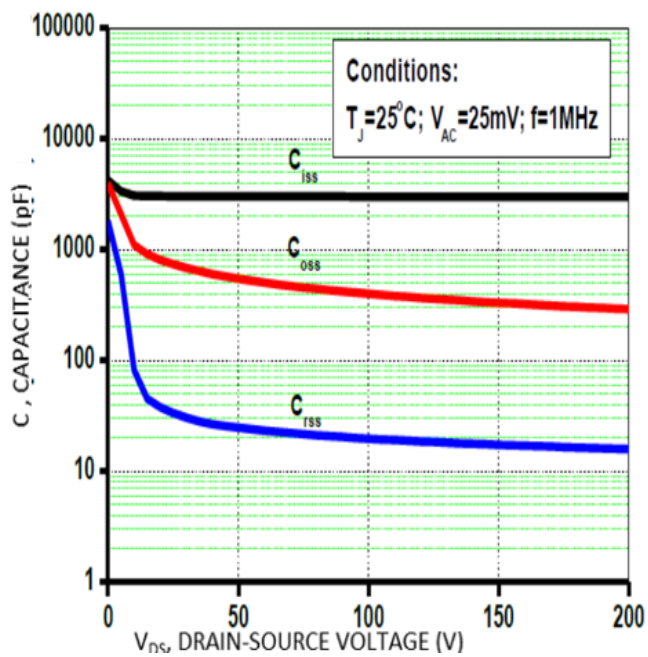
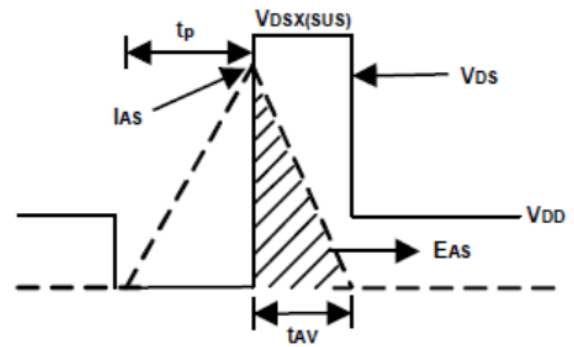
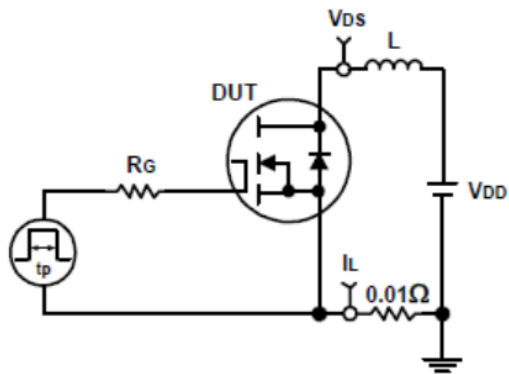
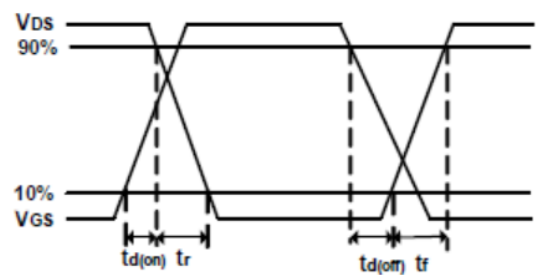
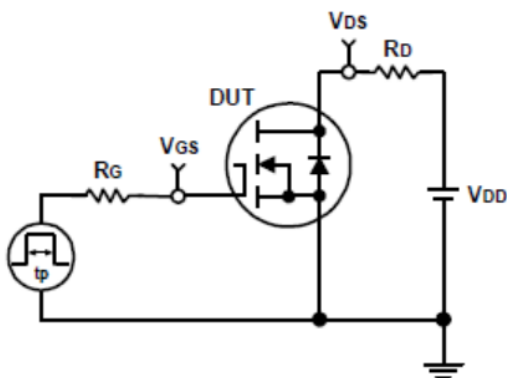

Fig.5 Capacitance

Avalanche Test Circuit and Waveforms



Switching Time Test Circuit and Waveforms



Package Information

TO-247

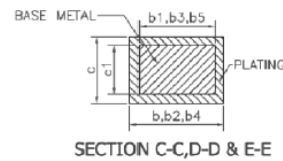
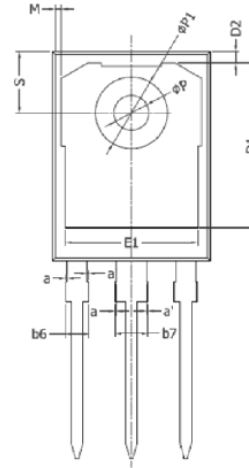
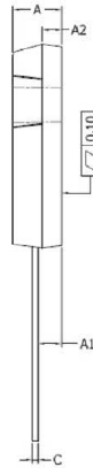
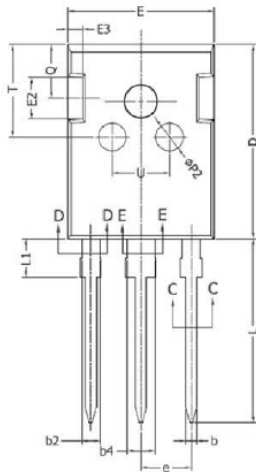

COMMON DIMENSIONS
(UNITS OF MEASURE =MILLIMETER)

SYMBOL	MIN	NOM	MAX
A	4.90	5.00	5.10
A1	2.31	2.41	2.51
A2	1.90	2.00	2.10
a	0	---	0.15
a'	0	---	0.15
b	1.16	---	1.26
b1	1.15	1.2	1.22
b2	1.96	---	2.06
b3	1.95	2.00	2.02
b4	2.96	---	3.06
b5	2.96	3.00	3.02
b6	---	---	2.25
b7	---	---	3.25
c	0.59	---	0.66
c1	0.58	0.60	0.62
D	20.90	21.00	21.10
D1	16.25	16.55	16.85
D2	1.05	1.17	1.35
E	15.70	15.80	15.90
E1	13.10	13.30	13.50
E2	4.40	4.50	4.60
E3	1.50	1.60	1.70
e	5,436 BSC		
L	19.80	19.92	20.10
L1	---	---	4.30
M	0.35	---	0.95
P	3.40	3.50	3.60
P1	7.00	---	7.40
P2	2.40	2.50	2.60
Q	5.60	---	6.00
S	6.05	6.15	6.25
T	9.80	---	10.20
U	6.00	---	6.40

NOTES:
 ALL DIMENSIONS REFER TO JEDEC STANDARD TO-247 AND
 DO NOT INCLUDE MOLD FLASH OR PROTRUSIONS.
 EJECTION MARK DEPTH 0.10^{+0.15}_{-0.10}